

# LIVERPOOL

**STRUTTURA** in vero legno rivestita in tessuto protettivo accoppiato con assemblaggio in colla e graffe.

**SOSPENSIONI SEDUTA** con sistema "elast" (cinghie elastiche).

**CUSCINO SEDUTA** gomma in poliuretano espanso densità 33kg/m<sup>3</sup> rivestita con fibre acriliche.

**CUSCINO SCHIENALE** cuscino in piuma canalizzata in fodera di cotone con inserto interno in poliuretano espanso densità 21kg/m<sup>3</sup>.

**RIVESTIMENTO** completamente sfoderabile nella versione in tessuto; sedute e spalliere volanti sfoderabili nella versione pelle.

Il modello può differire per alcune cuciture tra versione pelle e versione tessuto.

NON DISPONIBILE con letto.

**STRUCTURE** real wood covered with a protective fabric assembled with glue and staples.

**SEAT SUPPORT** "elast system".

**SEAT CUSHION** polyurethane foam density 33kg/m<sup>3</sup> covered with acrylic fibres coat on top.

**BACK CUSHION** polyurethane foam density 21kg/m<sup>3</sup> covered with a canalized feather cushion on top.

**COVERING** completely removable coverings in the fabric version; only seat and removable back cushion in the leather version. the leather sofa can have different sewings than fabric sofa.

NON AVAILABLE with bed.

**STRUCTURE** vrais bois avec rembourrage en polyuréthane et assemblage colle et agrafes.





**SUSPENSION ASSISE** sangles élastiques.

**MOUSSE ASSISE** mousse en polyuréthane expansé densité 33kg/m<sup>3</sup> et fibres acryliques.

**MOUSSE DOSSIER** mousse en plume canalisé avec revêtement en coton et insertion en polyuréthane densité 21kg/m<sup>3</sup>.

**RETEMENT** complètement déhoussable dans la version en tissu; dossiers et assises déhoussables dans la version en cuir. Entre les deux versions ils peuvent avoir des différences dans les coutures.

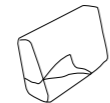
NON DISPONIBILE en convertible.

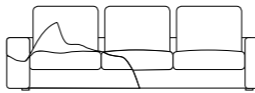
		<b>PELLE / LEATHER / CUIR</b>		<b>TESSUTO / FABRIC / TISSU</b>	
					
<b>STRUTTURA VERO LEGNO</b> REAL WOOD STRUCTURE VRAI BOIS	<b>SPALLIERA IN PIUMA</b> FEATHER BACK DOSSIER EN PLUME	<b>SEDUTA IN POLIURETANO ESPANSO</b> SITTING POLYURETHANE FOAM ASSISE MOUSSE DE POLYURÉTHANE	<b>SPALLIERA SFODERABILE</b> REMOVABLE UPHOLSTERY FOR BACK CUSHIONS COUSSINS DOSSIER DÉHOUSABLES	<b>CUSCINI DI SEDUTA SFODERABILI</b> REMOVABLE UPHOLSTERY FOR SITTING CUSHIONS COUSSINS D'ASSISE DÉHOUSABLES	<b>COMPLETAMENTE SFODERABILE</b> FULLY REMOVABLE COVERING COMPLETEMENT DÉHOUSABLE

## FINITURE PIEDINI / FEET FINISHINGS / COULEUR PIED OPTIONNEL

		
<b>STANDARD TITANIO</b>	<b>OPTIONAL CHAMPAGNE</b>	<b>OPTIONAL INOX SATINATO</b>

## COMPOSIZIONI FOTOGRAFATE / COMPOSITIONS AS IN THE PHOTO / COMPOSITIONS PHOTOGRAPHÉES

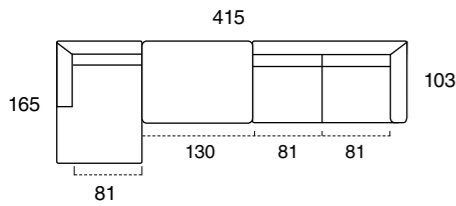
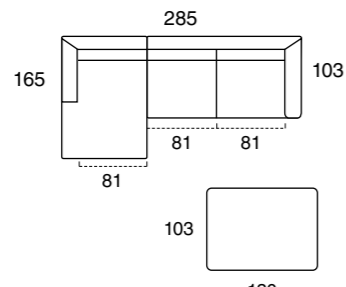
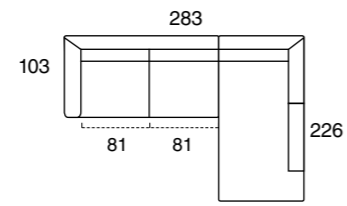
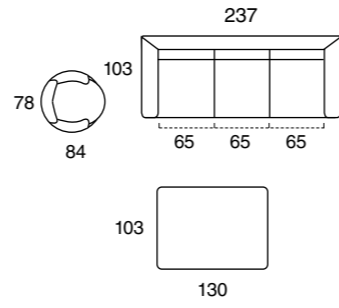

 <p>415 165 81 130 81 81 103</p>	 <p>285 165 81 81 103 103 130</p>	 <p>283 103 81 81 226</p>	 <p>237 103 78 84 65 65 65 103 130</p>
--	--	---	---

PAGE 74-75

PAGE 76-77

PAGE 78-79

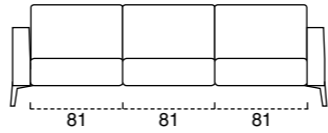
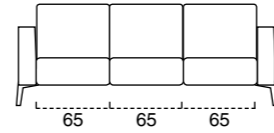
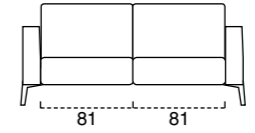
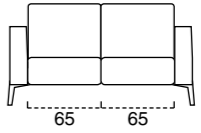
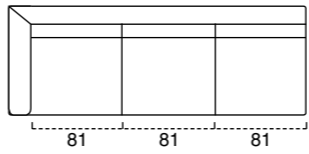
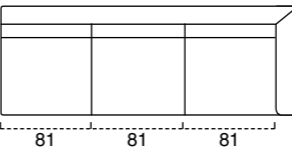
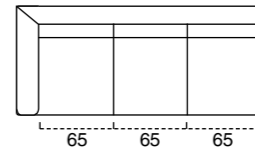
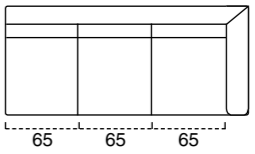
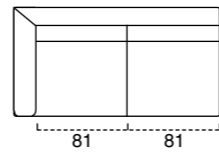
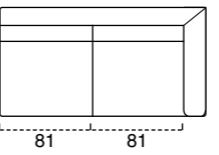
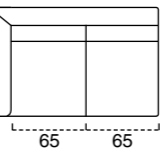
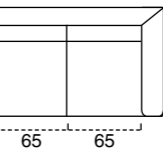
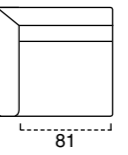
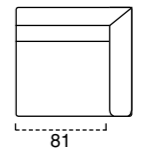
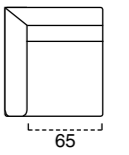
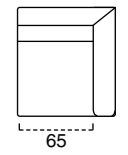
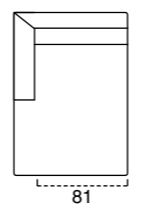
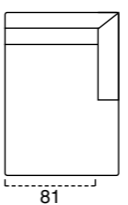
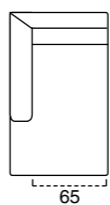
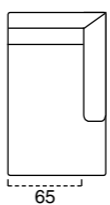
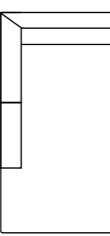
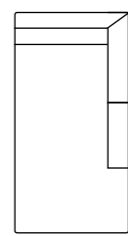
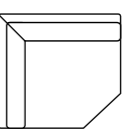
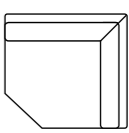
PAGE 82-83

<b>DIVANO EXTRA LARGE</b> 285 	<b>DIVANO MAXI</b> 237 	<b>DIVANO 3 POSTI</b> 204 	<b>DIVANO 2 POSTI</b> 172 				
<b>TERMINALE EXTRA LARGE SX</b> 264 	<b>TERMINALE EXTRALARGE DX</b> 264 	<b>TERMINALE MAXI SX</b> 216 	<b>TERMINALE MAXI DX</b> 216 				
<b>TERMINALE 3 POSTI SX</b> 183 	<b>TERMINALE 3 POSTI DX</b> 183 	<b>TERMINALE 2 POSTI SX</b> 151 	<b>TERMINALE 2 POSTI DX</b> 151 	<b>TERMINALE 1 POSTO GRANDE SX</b> 102 	<b>TERMINALE 1 POSTO GRANDE DX</b> 102 	<b>TERMINALE 1 POSTO PICCOLO SX</b> 86 	<b>TERMINALE 1 POSTO PICCOLO DX</b> 86 
<b>CHAISE LONGUE GRANDE SX</b> 102 	<b>CHAISE LONGUE GRANDE DX</b> 102 	<b>CHAISE LONGUE PICCOLA SX</b> 86 	<b>CHAISE LONGUE PICCOLA DX</b> 86 	<b>ANGOLO PENISOLA SX</b> 100 	<b>ANGOLO PENISOLA DX</b> 100 	<b>ANGOLO RETTO SX</b> 112x112 	<b>ANGOLO RETTO DX</b> 112x112 
<b>POUF</b> 130 	<b>POUF</b> 90 